

Article number: 03467045
 Description: Fluro Rod end EA 45D-2RS
 Note: 45

Measures

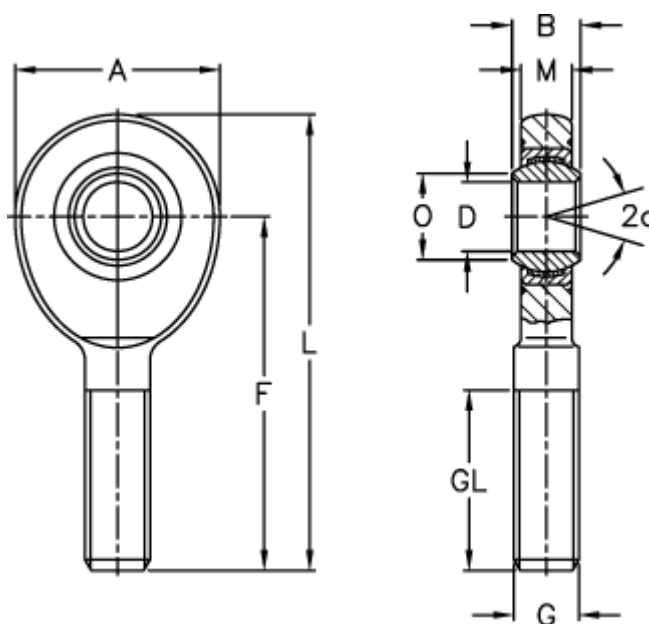

A	= 102	L	= 214
a (degrees)	= 7	M	= 27
B	= 32	O	= 50.8
D	= 45	Static drive kN	= 263
Dynamic drive (kN)	= 240	Weight	= 2610
F	= 163		
g	= M 42x3		
GL	= 94		